

# Applications in Interior+Landscape

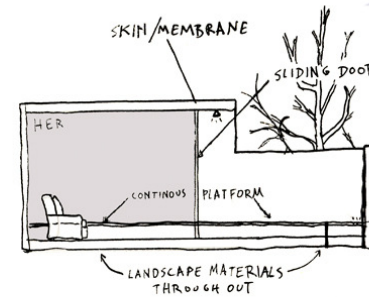
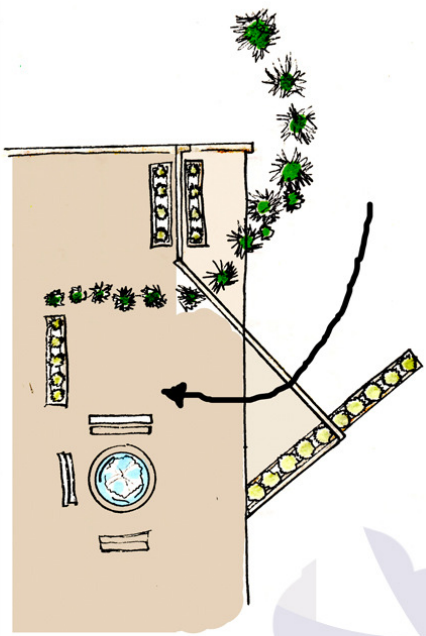

Drawing Influences From Both Disciplines to Create New Solutions

By Jean Carlos Moreno

## Abstract

Applications in Interior+Landscape is a study on how influences from the studies of Landscape Architecture and Architectural Interiors may provide solutions to certain sites in our modern built environment. In addition, the study also focuses on intentionally finding a connection between certain Interior spaces and their immediate landscapes for better access to Landscape atmospheres without being out in the elements, for more convenience in dense urban sites where a personal exterior space is often missing or inconvenient to visit, and for having the luxury of bringing the landscape in or the Interiors out for more inviting sites, less concealed spaces where desired and for any natural benefits associated with these.

The study concentrates on many different applications that an individual or a multidisciplinary firm that employs Landscape and Interiors professionals may use in designing and renovating certain sites.

The main focus is on the common ground of space planning between small scale Landscape and Interiors which builds, decorates, transforms and reprograms where Building architecture and dated Landscape design has previously worked upon.

Examples and concepts are presented and then developed for new applications.

The study ends with a small scale Landscape urban infill design and an Interior Design of the space right next to it; designed simultaneously in regard to each other.

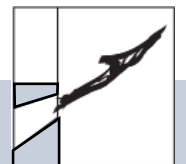

## Dedication:

To my parents for making me believe I could achieve something bigger than what I initially set out to do, and to the hard working people of El Salvador for maintaining the beautiful land and always struggling for progress.

## Biographical Sketch and Log explanation



I am a first generation American born and raised in San Francisco CA from Salvadorean parents. I have lived in San Francisco most of my life where I got an Associate's degree in Architectural Interiors from the City College of San Francisco before transferring to Davis to study Landscape Architecture. I am inspired by the experiences that different eras bring to our lives and the way in which they influence us. I strive to create new spaces in which to have us become the protagonists in our own lives within these settings in order to have new great eras in the future.

In creating this project I had many thoughts and struggles in creating a definition of what Interior+Landscape is in this study. To explain this, and also any influences that shaped a particular thought process of simultaneous interior and exterior design, I have included a brief log in italicized text to complement the information presented on certain concepts throughout the paper.

Thanks for reading.

Jean C. Moreno

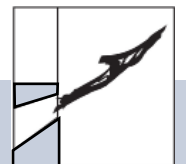
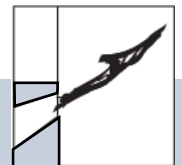

Table Of Contents:

pg1.....	Abstract
pg2.....	Dedication and biographical sketch
pg3.....	Contents
pg4.....	Preface
pg5.....	Definitions
pg6-13.....	perspectives, trends and influences.
pg14-15.....	Design 1
pg16-18.....	influences
pg19.....	Author's concept
pg20.....	Design 2
pg21.....	Design 3
pg22-24.....	Design 4
pg25-28.....	concept influences
pg29-31.....	Design 5
pg32-46.....	Main Site: Analysis
pg47.....	Initial concept
pg48.....	Restaurant proposal
pg49.....	shortcut traffic way and integrated concepts explanation
pg50.....	Site Master Plan
pg51.....	Site Physical Model
pg52.....	plants used
pg53.....	shapes theme
pg54.....	Main ramp doors design
pg55.....	textiles used
pg56.....	wallpaper used
pg57.....	rugs and lights used
pg58.....	material boards
pg59.....	teak and furniture
pg60.....	lighted trellis design
pg61.....	lighted fountains
pg62.....	connection to landscape system
pg63.....	concluding log
pg64-65.....	Bibliography





## Preface

The influence for this project initially stemmed from my love of two worlds; the world of Interior Architecture and Design, and the world of Landscape Architecture. The common ground between these two types of space design created the idea that they can indeed be for holistic experience and atmosphere if designed for simultaneously to have a sense of journey; to know where we are in respect to where we wanted to initially enter.

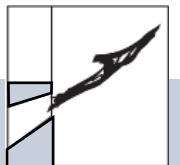

## Definitions within study:

### Interiors:

Interior Architecture creates interior space size, length, shape and adjusts for function and lighting by manipulating architectural elements of the interiors usually, but not necessarily, alongside the architect. This discipline often overlaps with Interior Design which determines the finishes for the space by completing the final spaces and corridors through final positioning installation and accommodation for the designated program. The spaces will accommodate living, hosting, public or governmental functions. For the purpose of this study, the two will be merged into one which will simply be called "Interiors".

### Landscape Architecture:

Landscape Architecture creates outdoor spaces at a small and large scale. Large scale may interconnect many parts of a city or wild area. Small scale usually concentrates on the details that create a space's atmosphere and function. In relating to Interiors, small scale Landscape Architecture will be used for this study.

Interior+Landscape for this study will be the merging of the aforementioned disciplines' influences to create a dialogue between certain Interior spaces and their respective immediate exterior. The cases in which these procedures can be implemented will yield a sense of place in the landscape while indoors. Interior+Landscape strives to create spaces that connect the interior and exterior to provide a continuous experience that breaks away from being strictly in the inside or the outside and having completely divided experiences when traversing the two.

**Gesture:** A form or shape, an element, a unit or body of units composing a shape with a certain dynamism.

**Skin:** The defining membrane of a site. Conventionally, it is the building wall. In some of these studies, it may be an outside barrier if the building wall is penetrable through sight, sound, proximity, etc.

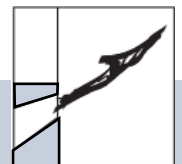

-History, Perspectives and Trends:

“The essence of Modern architecture is based on continuous space and seamless connection”

Petra Blaisse (Inside Outside).

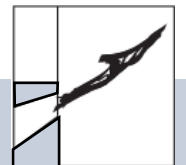

Connections and elements of Interior+Landscape have always existed because space design overlaps some times unintentionally, other times as a need to give and take from each other. The first project that boldly focused on bringing the landscape indoors at a large scale was the glass and cast iron “Crystal Palace” by Joseph Paxton in 1851. This huge greenhouse type structure had interior rugs and decorations alongside interior street trees.



As the professions of Interiors and Landscape evolved, designated areas were developed as inside or outside, dividing not only the projects, but the spaces as well. This division was also a product of limiting factors such as the need for concealment from outside conditions, different codes and also how the business grew and focused on the outcome of either the Landscape or Interior, therefore in many cases failing to regard the other.

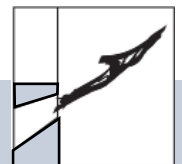



Hermetic structures keep out unwanted elements and guests.

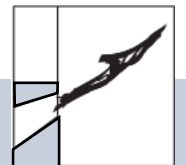



The two disciplines have taken different focus...

In Interiors ,much time and effort goes to the details. Use of values such as tones, lighting and appliances and mechanisms for hospitality are well thought out. Material samples, swatches and other product selections alongside with corridor creation for program through object positioning, and interior wall extrusions or wall demolitions are the main concern of the designer who strives to program interior built environment for updated use; much like changing the organs of the structure to create new processes within this “animal”.

Landscape encompasses the exterior built environment. Urban landscape “rooms” are always interconnected to a higher system of landscape that they are a part of. Materials that withstand outside elements are preferred.

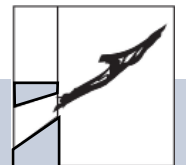

*-Log: After trying to find a place for Interior+Landscape projects, I rather found a smooth way to integrate these influences. The playfield is set. You either sign off for a Landscape Architecture project or for an Interiors project. However I now find that within these small scale commercial, public or residential projects, there always pops up the need to reach into the repertoire of the opposite world. I rather like the latter projects because they blur the edge of space design yet they keep each other out of their "personal space"; they keep out of each other's way. I am glad to have found this way to integrate these influences, because my intention is for the benefit of design and not to create more superfluous titles that add to the many branches that are growing out of the design professions.*

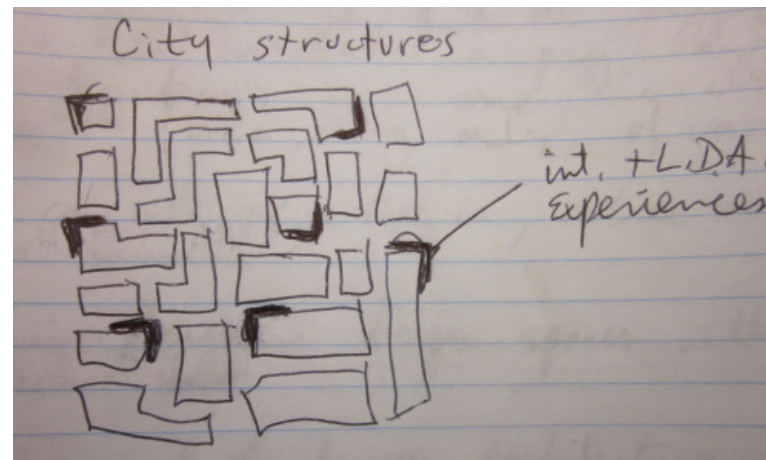

Interior+Landscape can be distributed as small connections within a metropolis.

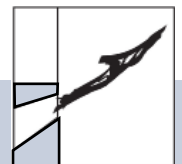

## -Existing Examples:

These examples represent different ways in which to blend interior and exterior space. Although some of these works are in the realm of building architecture, they help portray what kind of procedures Landscape Architects and Interior Designers can take in order to design with their counterparts in mind.

\*The actual job of Interior+Landscape would be done on pre-existing landscape and building where interiors and immediate (small scale) landscape are finished and finally programmed.

### Inviting space:



-Floor design spans through to Interior.

This very subtle floor design that spans exterior and interior space and creates a flow of one's view to regard the information desk within.



Landscape Materials and Interior furnishings

Landscape Architecture Material finishes yet furnished with Interior Design Influence.

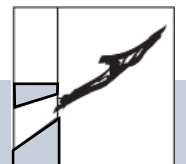



Open Spaces in Concealed Interiors:  
Hermetic Interior divided into Interior and Landscape.

Landscape materials.

interior space has Landscape influence. The need for breeze and atmosphere of the exteriors creates the opening in these two examples. To accommodate for any outer elements, these materials are chosen instead of Interior materials. The lighting is all interiors, even the ones on the outer part because the space is still concealed as an interior space. The essential element which makes this unique feature possible is a secured sliding glass door which cuts through the continuous features to unite the Interior and Landscape in a convenient way that does not have a feeling of leaving your private comfortable life activity in pause to catch a bit of the much needed landscape.

This room (top) is programmed to one specific need, that is, for leisure and contemplation because it is a part of a large house. The other (bottom) is a direct connection from living room to yard.

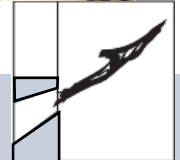

This house was renovated to have the exterior area be part of the dining room. The same flooring is continuous all the way through.

This concealed exterior area is very accessible throughout a daily routine and is private enough to be inviting throughout many of one's moods. It is a great luxury to have this convenience in one's own residence.

However in dense urban environments where over population reigns, apartment buildings have only one or no open area for it's many residents, and often, residents do not have convenient access to the area or cannot feel comfortable there because it is shared with so many other individuals. These people often do not have an exterior space to spend time in and end up going through their lives without it.

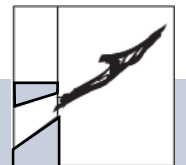



Authors design:

design for an interior opening in a multiuse room (kitchen, dining and living room), is a partial solution to having every tenant have their own convenient private open space. It is very important to have direct outside breeze and conditions in our life, so even a small space like this goes a long way.





Planters behind teak informal seating make this area an outside condition. Exterior tile runs into the interior as a hint to the outside (once the side sliding wall is closed), otherwise, interior wood flooring along with all other interior materials are used on the inside as is in a conventional apartment room.

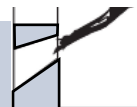
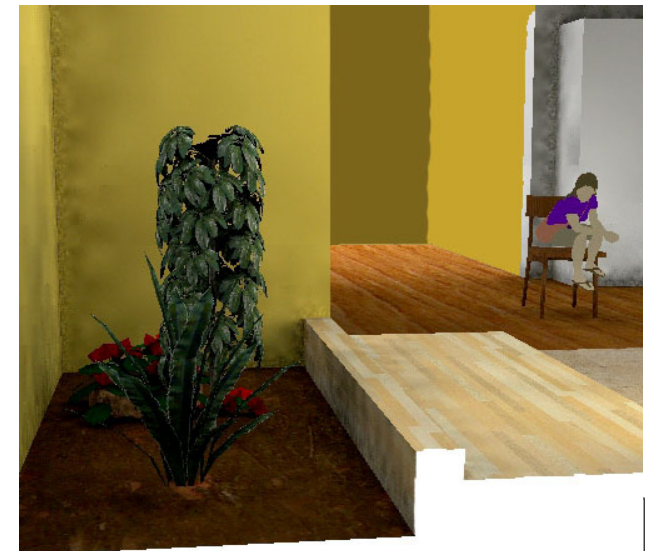

*-Log: When I was growing up in my parent's second story apartment in San Francisco, I had the luck of having an apartment that opened up to a very small exterior space which was initially used as a corridor to go down the some stairs that led to a space with concrete ground (the area that was supposed to be a yard) where the landlord stored his things. This downstairs area was a great place to play as a child and I have fond memories of this such dilapidated place.*

*When I grew older, my routine had more presence and it became inconvenient to go downstairs if my mind was already engaged in something else, plus it had very little privacy. However I always had time to go to the immediate small exterior space which was made private by a large avocado tree that blocked outsider's sight. Later on I realized how this very small exterior space (with canopy) was to me, it was my landscape and then I realized that everyone else in the building, or in most of the other buildings in my neighborhood, didn't have such an opening to the landscape. I think these things are hard to realize if they are not present in our life, and most of the other people don't realize their need for a little landscape if they are busy, and trying to live in a small apartment.*

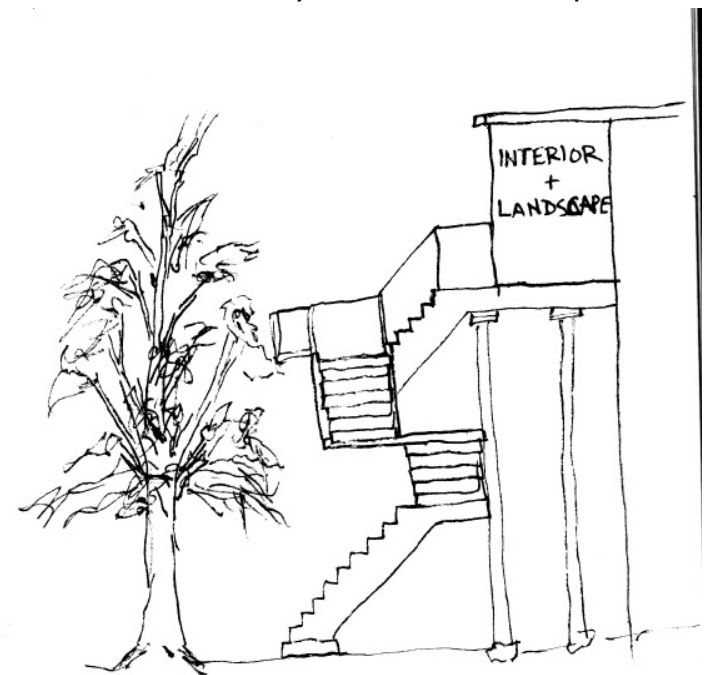

JEAN CARLOS MORENO

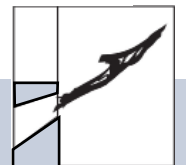





Material Mimicry for continuous experience.

This is an example in which the outside material and the inside material look very similar, but are actually different. The interior variety of this roof is a textile like material called baty line, while the exterior variety is called precon traint and is a hard surface.

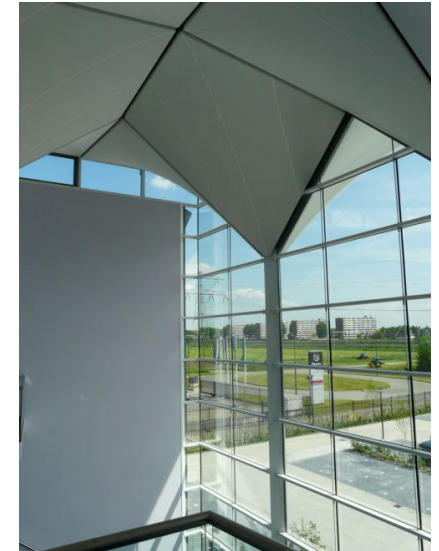

The hard material starts just after the glass skin of the building, and the textile of the interior ends at the glass.

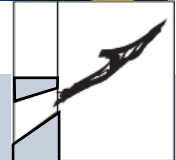
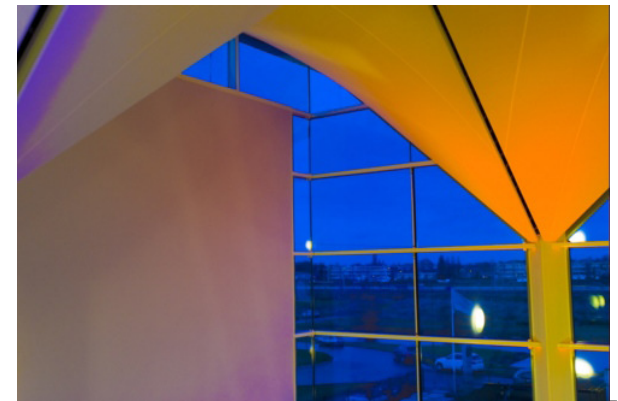

Example by UCD graduate Alexandra Witte.

This example by UC Davis graduate Alexandra Witte of a museum design is an example of continuous gesture. These may be art pieces, continuous paths, continuous plantings, materials, structures, or patterns that start and conclude with the same material and form, or that evolve materials and end in a similar way in which it started.

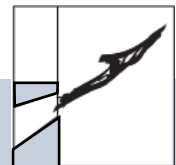
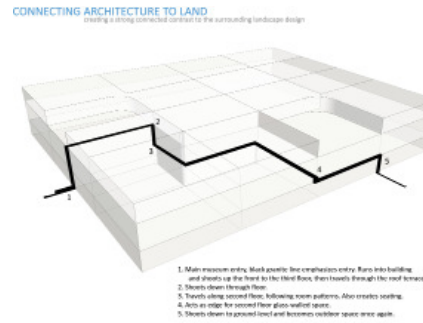
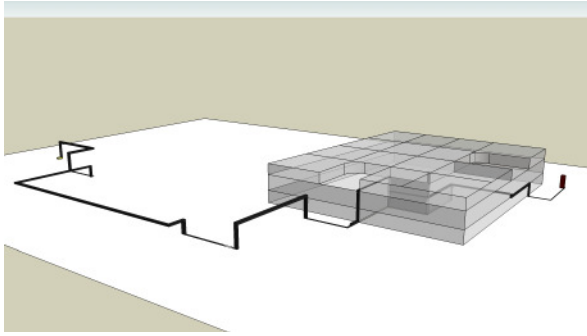



Author's concepts:

Plants as continuous gestures.

Plants can also be used to have the same desired continuous effect. As in the plan to the right, they can direct traffic to an interior space by starting the shrubbed path with sun plants and ending with interior plants that have a similar form or using plants that can thrive in both interior and exterior setting

Another form of of continuous plantings (next page) uses this (bottom right) typical planter product from 'jardini erecorp' that is generally used to hold a chain of either interior or exterior plantings. In this case, however, a variation of this product will be used for continuous plantings of an interior vine and an exterior vine that would hang down on opposite sides of a glass skin, thus creating a subtle backdrop that hints at a plant going through from interior to exterior.

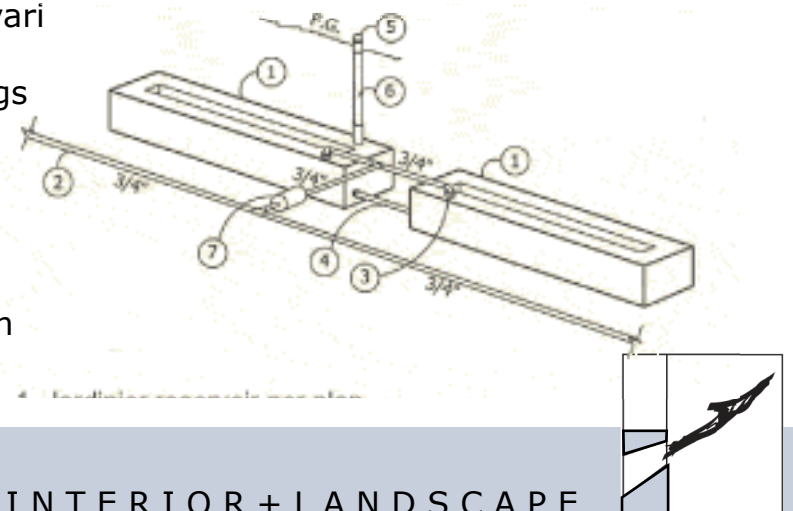
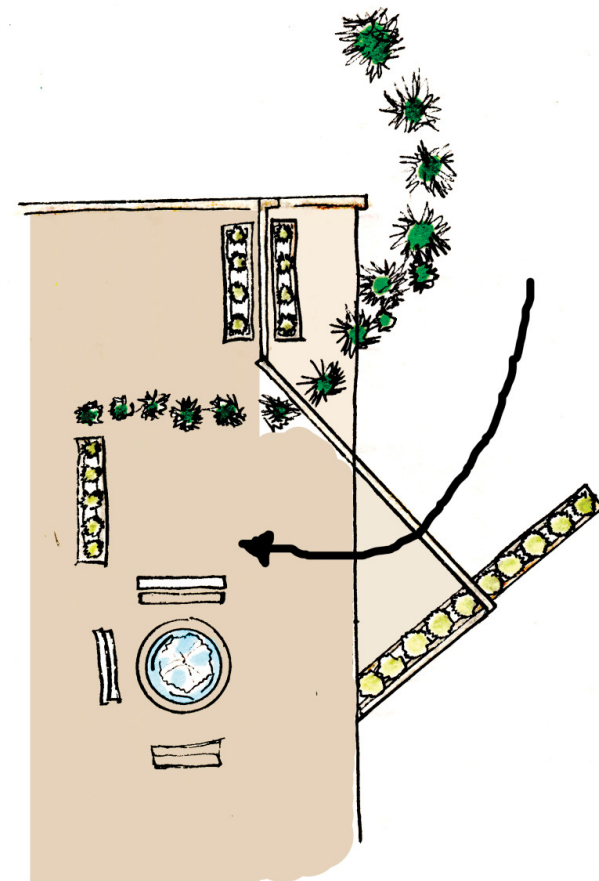

Author's Design: Pothos vine/English ivy vine design in a cafe



The Jardinierecorp planter is placed on the continuous roof between a small exterior and an interior opening in order to distribute a pothos vine to the interior and a single English ivy vine on the exterior. In order to have this function, the planter is turned 90 degrees from it's conventional position to span to the outer area.

*Log: This design should be considered background decoration, and should not bring attention to it. Instead it should be a background that brings exterior atmosphere to the setting, therefore, the method is not hidden from the viewer, but, it is not presented either in order to not trick the viewer, but not bring attention to it either. If the user happens to notice the method, it should remain an afterthought*

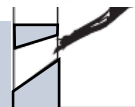
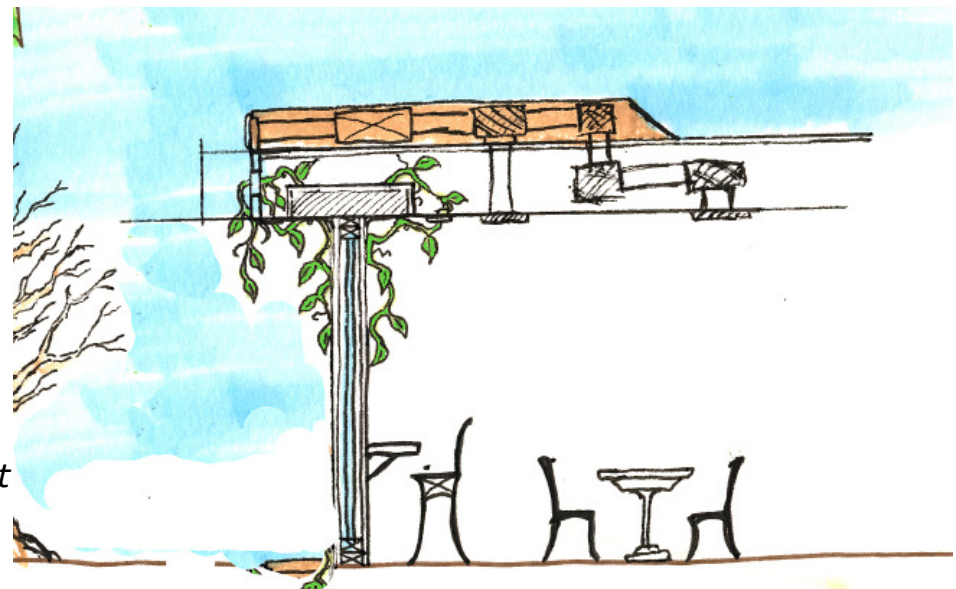

Author's design:

Inside Outside green wall prototype.

This prototype for an interior and exterior green wall supply ventilation system uses exterior full sun plants on the outside to carry out the usual exterior green wall functions in addition to filtering the supplied outside air before the mechanic filtering process even begins. The interior plants on the respective inside green wall further filter the processed air to remove any remaining exterior agents from the air for ventilation. The air goes through a pipe, and is propelled inside by one or multiple fans (not pictured on the lower right graphic).

The outside green wall can be implemented or shaped in a way that foreshadows the interior wall, thus creating a mental connection that invites the viewer to see the conclusion of the process inside, and also gives the interior user a sense of place in the journey of traversing through the building.

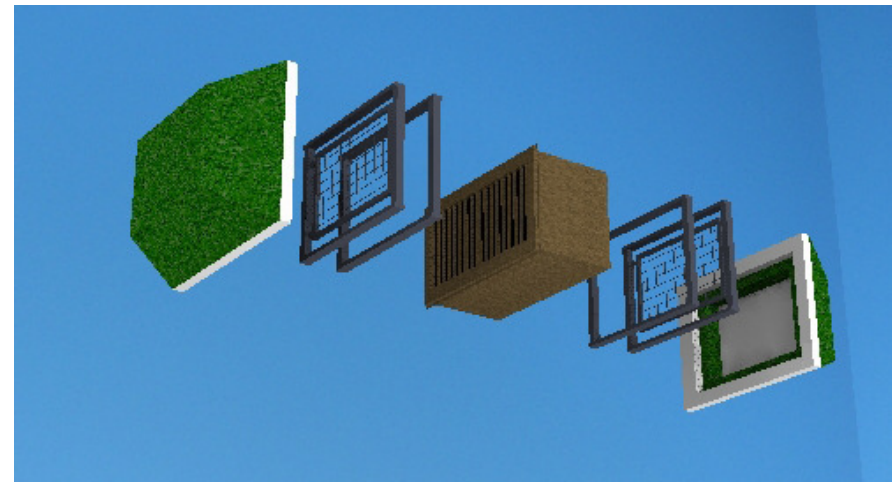
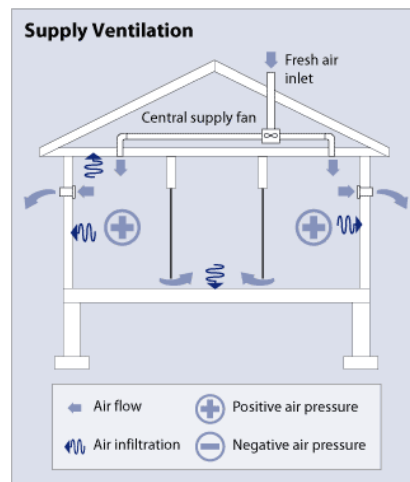

*Log: Supply ventilation filters outside air and brings it into the interior.*

*After it circulates, it then goes back out through an escape vent.*

*The main issue with this method is that outside debris is not thoroughly filtered by the mechanic filter. Based on this system's logic, I believe that putting plant layers that stand on an extra frame at each end (inside and outside) of the ventilation mechanism, may filter this remaining debris as well as beautify the outside and inside wall if integrated into the design correctly.*

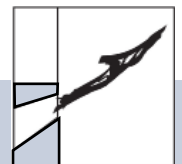



## Author's design: Museum Supply Ventilation with Green Wall

This simple design is an abstract organic plant growth form that lightly follows the pattern in which it is cast (semi varied concrete units). Here, the design is implemented on two exterior wall options.

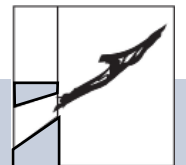
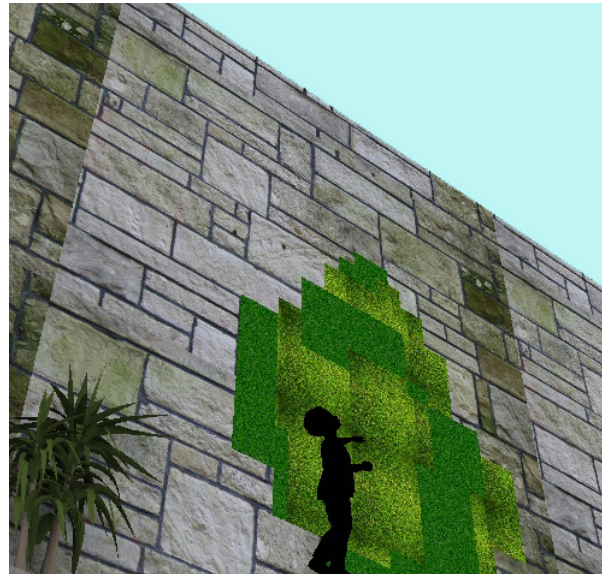

## The Interior continuation.

After fans propel the exterior air into the filtering mechanism, it is then taken sideways through the wall, into a mechanic filter, then through to a second mechanic filter, after which, it is propelled by yet another fan as it makes it's way to the interior living wall placed a few feet to the side of the exterior one, but with the same (or similar) body and pattern. At that point, it is filtered for any possible remaining exterior debris and distributed into the interior possibly through a decently sized vent on the center of the greenwall. The air is then ready to circulate the interior space thus providing fresher air into the interiors and minimizing sick building syndrome. After it circulates, it goes through an escape vent to make space for new filtered air coming in.

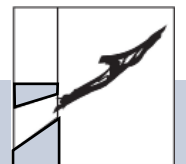



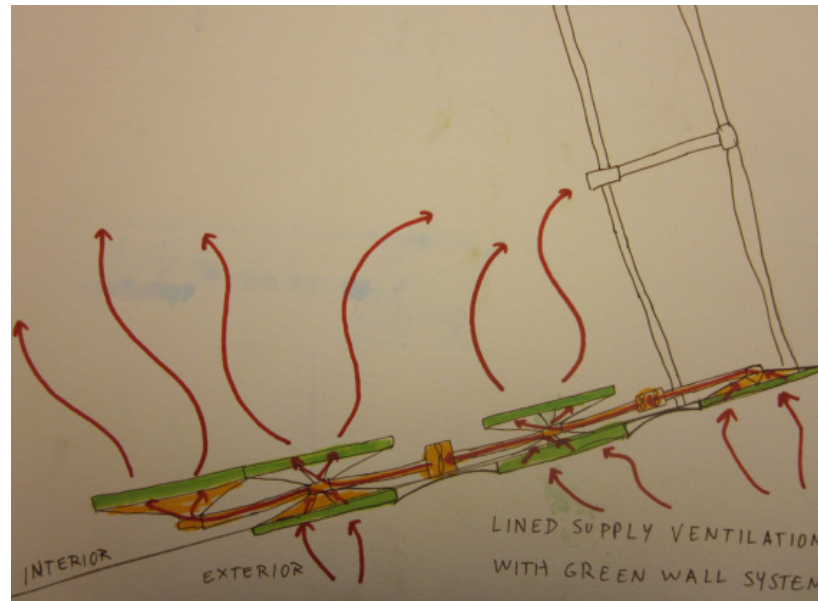

*-Log: The influence to create a sense of place in regard to the surroundings stemmed from experiences, such as discovery as can be experienced in works such as-(LDA BOOK) that have a continuation and a conclusion. The influence also comes from everyday instinct to stop and contemplate your road, the chosen path in time (earlier life experience) or in the physical world; for example, after climbing a hill, there is always the instinct to look back, look down and see where we went, to reminisce our position in history. Often times, I forget transition points in my life. For example how I got to be my current self after remembering myself in another stage in life. After I make the connection (and remember the transition point), I am fascinated by how my story developed. I find a parallel feeling in the physical world where I can discover the feelings I had when starting to traverse a space, and how they develop throughout traversing this space.*

*Often times, interiors that are completely different than what attracted me to the building in the first place make me forget what fascinated me about the building's façade to begin with.*

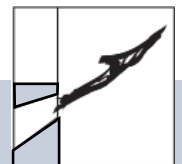

## Deconstructivism

An important part of Building architecture that strived to have a formula that worked by manipulating ideas of a structure's surface or skin, there are many forms of deconstructivism that came about after the initial movement of the 1980's, and some styles are "deconstructed" to the point of having Interior+Landscape areas and connections.

In this example (by Rem Koolhaas) non-rectilinear shapes serve to distort and dislocate some of the walls, canopy and structures. This "controlled chaos" creates complex spaces which work in keeping outside elements out by having a system of angles that leave the inside spaces intact, even though the interiors may be open to the landscape.



Author's drawing:  
This drawing shows the concept of angles keeping out the rain and some other outside elements. It does not represent the example shown above.

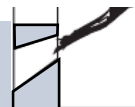
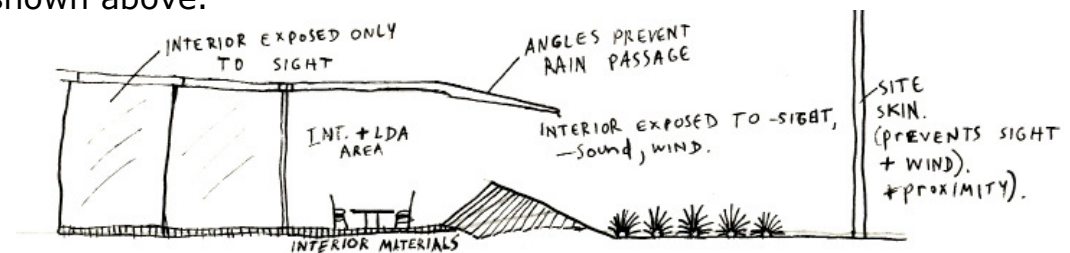

## Exterior Skin

Here, the outside area edges and vegetation serve as the skin of the place, not letting any outside individuals or elements in and blocking out outside vision of the Interior even though the glass is open to light.



No outer skin makes this transparent membrane be penetrable by sight.



Author's Concept Drawing.  
(only partially based on the above example).

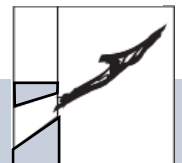



Transformations:

Landscape takes over Interior (left):

Opening the glass doors turns this space into an exterior room. By letting the landscape in. The site's skin can be seen in the far Background



Interior+Landscape parallel forms:

The interior stairs are designed in the form of it's respective view (mountainous landscape)



Interior Takes over Landscape:  
This Interior space was created by on a non functioning street. Exterior hardscape remains.

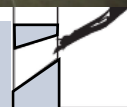



Influences: continued

Bringing it in:

Landscape materials used indoors.

This concept goes back to the initial idea of the crystal palace by Paxton. We bring landscape materials in to have the presence of an outside area, but being away from wind and elements.

This concept can be tied in to the continuous gestures and plantings to have a continuous pathway from outside in.



Interior Influence: Textile screening  
Creates wanted textures, and colors that add to the designated atmosphere of an interior by draping or masking existing elements.

Example: Petra Blaisse Kunsthal (Netherlands).

Working with deconstructivist architect Rem Koolhaas, Interior and Landscape architect: Petra Blaisse integrated many different Interior and Landscape connections in the Kunsthal museum.

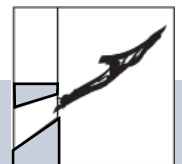

Landscape Influence: Weather in design.

Author's Design Prototype:

This design uses a type of technology that has been used on bathroom faucets. The light that emits on to the water is turned on through water pressure that is produced when the water starts running, and it is actually powered by this pressure as well, so there is no need for batteries or extra light switches.

Applying this technology into a water fountain creates an opportunity to have the weather (rain in this case) determine a moment in the design.

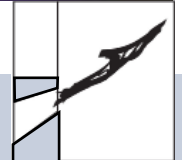

Rain determines when the fountain is turned on by

- 1.) Creating the pressure for the light to turn on.
- 2.) Providing the water itself to create the fountain's water movement over the backdrop slab.

Log: Determined days

In a residence, a lighted interior fountain is usually inconvenient and turning it on feels unnecessary.

However, if a rainy day determines whether the fountain functions, it then becomes a backdrop in place and mind and also becomes a lighted comfortable setting on a day when trips outside are inconvenient.

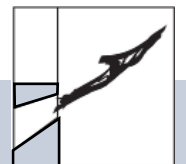



-Author's design: Residential lighted fountain

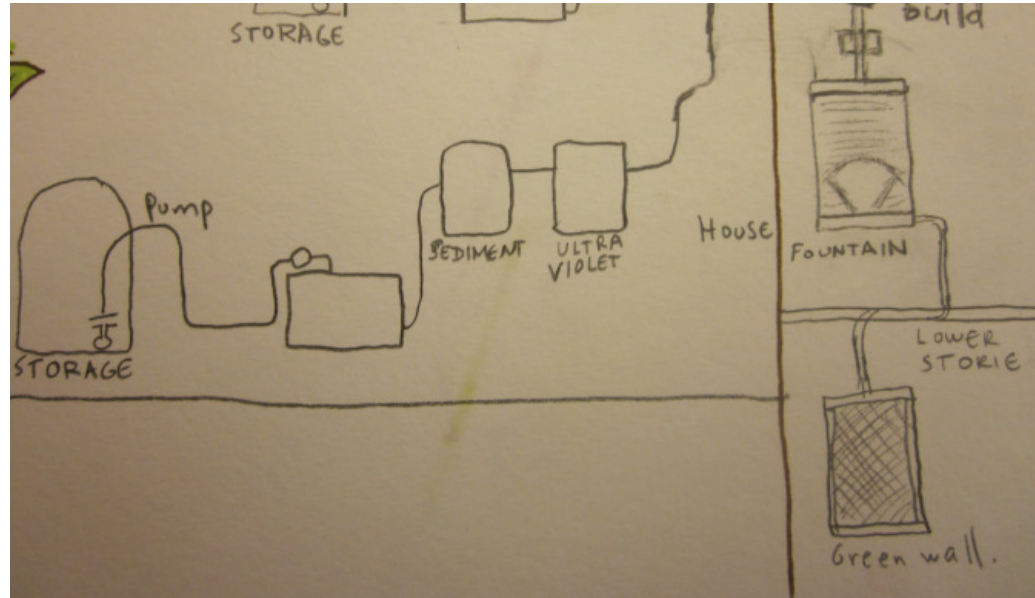

This existing product is used for the prototype connection to a water catchment mechanism. A simple concrete slab for the water to descend is needed under the pressure powered lights to create the fountain of the design.

Green wall receives water after it goes through fountain.





## Main Site design:

The main design for this study is an infill project in San Francisco for the immediate area leading to the Embarcadero Center elevated walkway and simultaneous Interior design of the currently unused Interior space next to it to the left (on the right side of the 450 Sansome "Glass Pavilion" facade).

Main site at 450 Sansome.

Unoccupied Interior (left) is one third of the 450 Sansome first floor space. The central third is the building lobby and the other corner is a cafe.

The open space by 450 Sansome (below) leads to the eventual entrance of the Embarcadero walkway. It is located in between the 450 Sansome office building and the historic old San Francisco federal reserve bank.



## Site Images: Interior Space

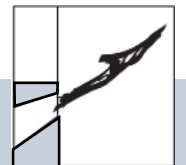

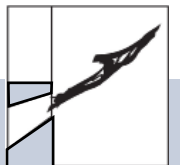



Site Images: Exterior space

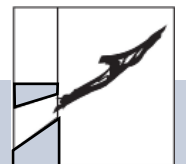
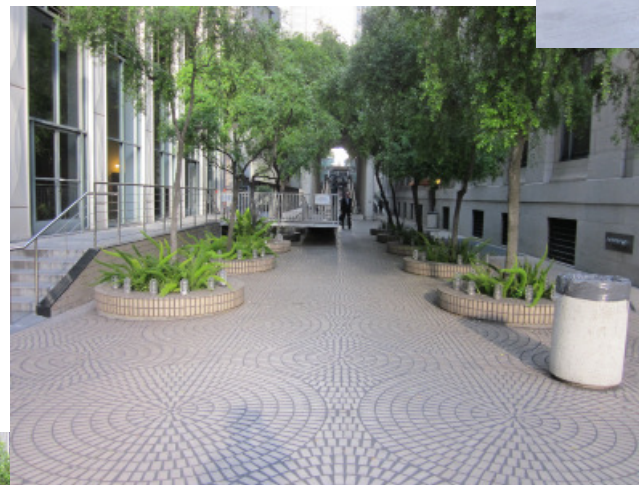



Side of old SF Federal Reserve



Looking towards Sansome st.

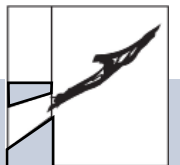

The newly renovated facade (Glass Pavilion) by architect Mark Dziewulski



The building's new glass façade has improved office leasing space in the last few years. The glass space is divided into 3 sections each with their own entrance; on the left, there is a chain café, in the center; the building lobby and on the right side (next to the exterior site) is the currently unoccupied Interior space.

This opportunity for simultaneous infill design and Interior Architecture, makes way for this

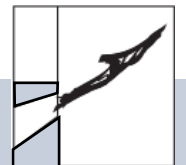



Embarcadero elevated walkway Images:



The elevated walkway is a concrete structure which spans 4 blocks starting at this open area/alley right in between Sansome and Battery streets (near the Barbary Coast/Old Shoreline Trail), and ending at the Justin Herman Plaza by the Ferry Building (by the SF shore). The site is located just before the elevated walkway starts (Sansome and Commercial) and thus currently creates a void

Continuous street level plaza mall under walkway

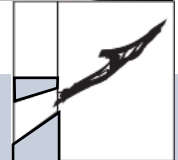

Site Drainage pattern

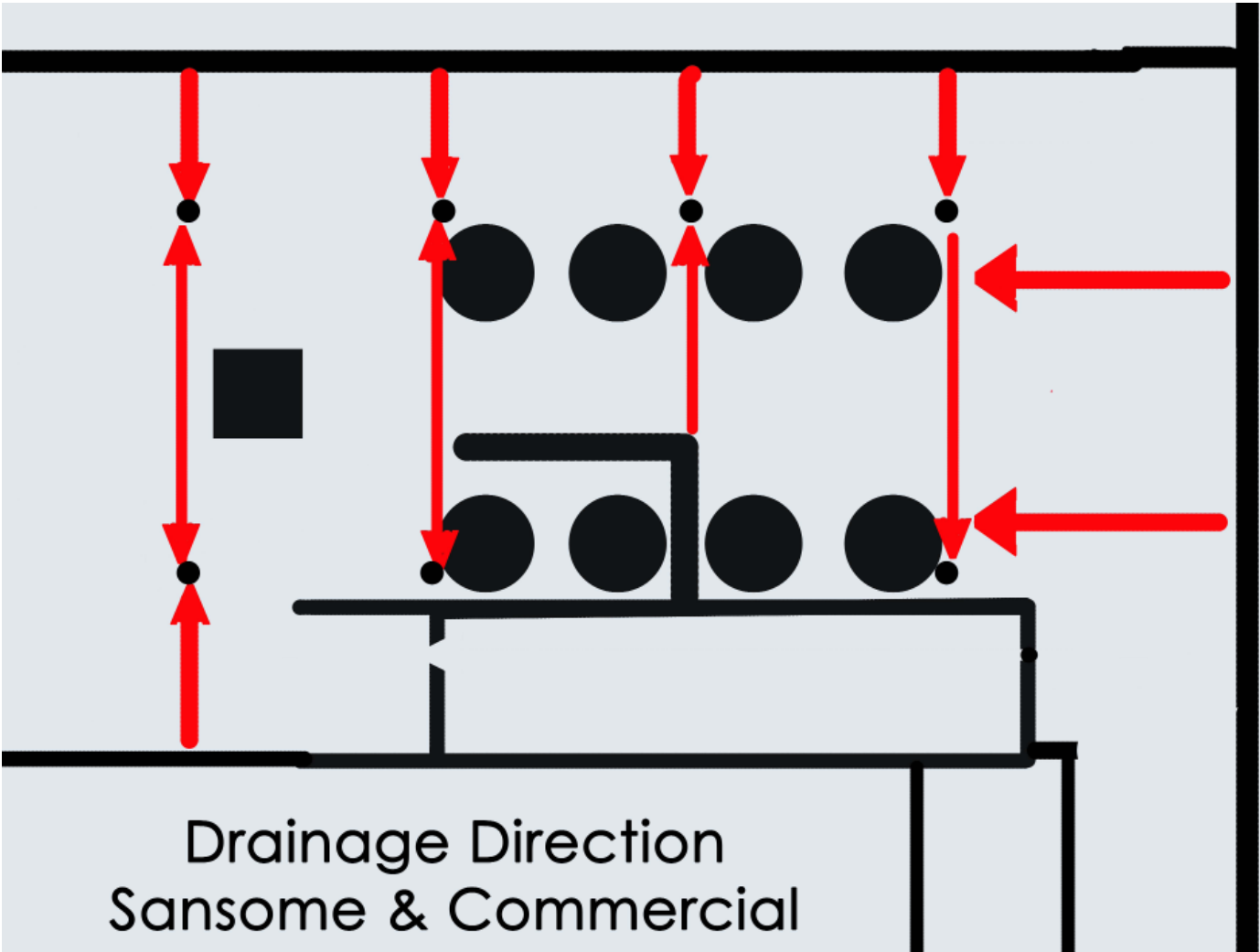

Drainage Direction  
Sansome & Commercial





Context Map: Elevated Walkway



Starting at the site (between Sansome and Battery streets).



Ending at Justin Herman Plaza





Context map: surroundings

North Beach District.

China Town

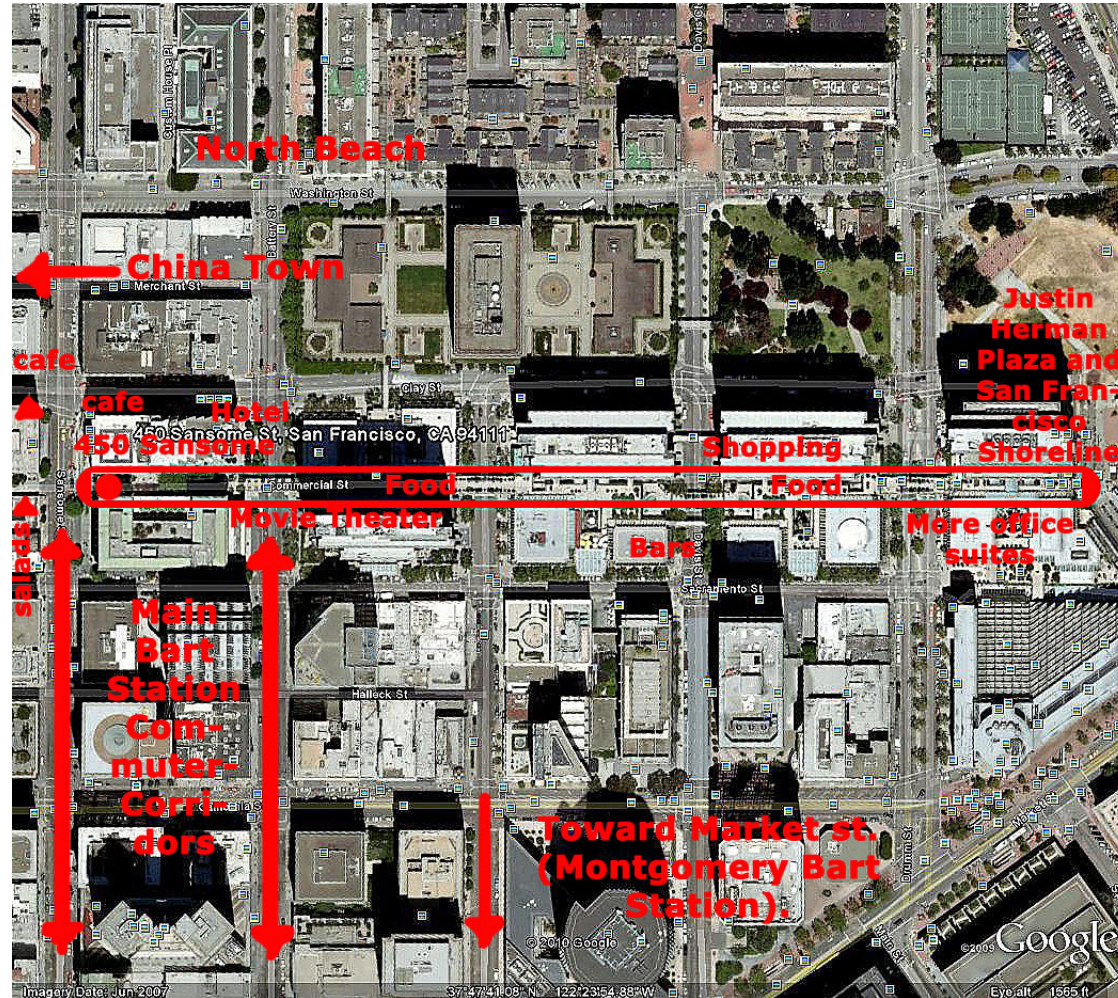

Justin Herman Plaza, Ferry Building and Shore.

South: Market Street with Bart train connection.

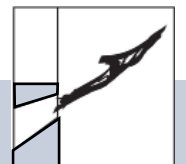



Towards BART station (subway train)

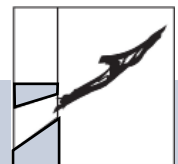
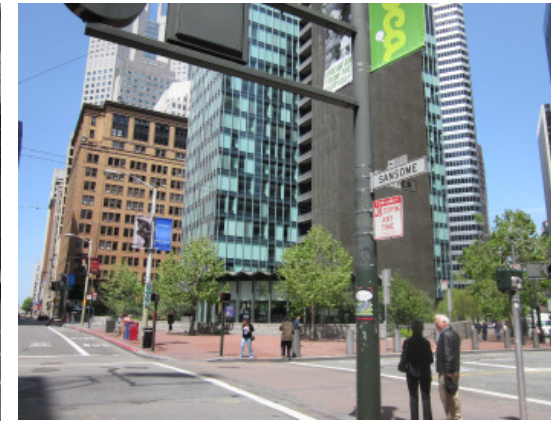
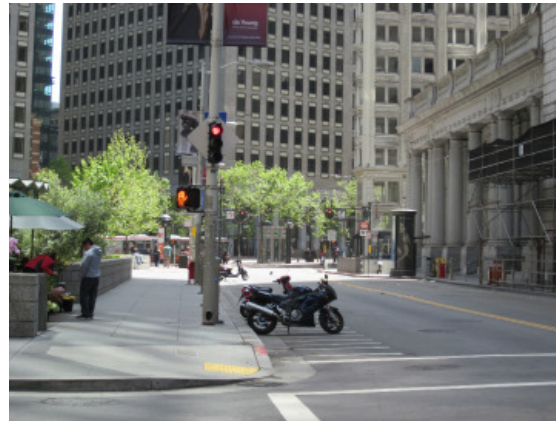



Le Meridien Hotel (first building along walkway, next to site).



Entrance on Clay st.



Room window detail



Back of hotel  
(Facing exterior site).

Entrance to Elevated walkway:

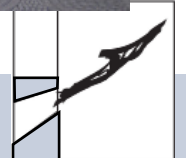

450 Sansome Historic Pictures.



450 Sansome facade before the Glass Pavilion renovation



450 Sansome exterior space photo with removable chairs and tables from old restaurant.

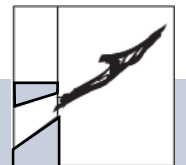



Site observations:

Pedestrian traffic

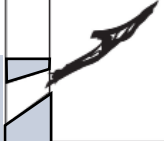



### Pedestrian Traffic and behaviors...

Monday through Friday the sight is used extensively, solely as a corridor for commuting to and from the office or work space when going out to eat. Even though it is used a lot during these times, the three existing main pathways are used by only one person or a group of people at a time. If the center one is being used, the next person to traverse uses the right (next to the old Federal Reserve) path and so on. No one usually stops there, except for cell phone use during non rush hours. During the night time, no one uses the site because it is too dark by Battery st. and it is too aggressively lighted on Sansome (probably so no one will sleep there).

### Building users' use of the site...

The 450 Sansome building workers come out through the lobby (the middle doors on the Glass Pavilion) and then walk the Sansome sidewalk if they are to go through the site because there is no straight connection. They go through the site in order to reach establishments that are located on the walkway. During rainy days, they have to hurry through the space and then get under the walkway (instead of normally going up the stairs to the restaurants. They go back with the food in hand if they are on short break.

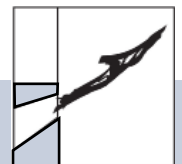

Initial design concepts:

The initial concept was to have a gradient of Interior space, transitioning to open interiors, then to it's respective outer landscape and finally to permanent landscape that connects to the city's large scale system, between the interior and exterior spaces.

The area's respective immediate landscape is to be packaged together with the interior renovations and programing in order for both of them to have as similar budgets, materials and lifetime as possible, and also to make them open to new renovations in the following decades (as Interior works usually have) as opposed to the more permanent landscape which will include higher budget materials and focus on connecting to the city's framework rather than embrace it's respective Interior space.

#### Interior to Permanent Landscape gradient

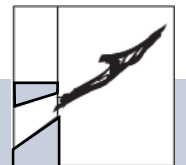
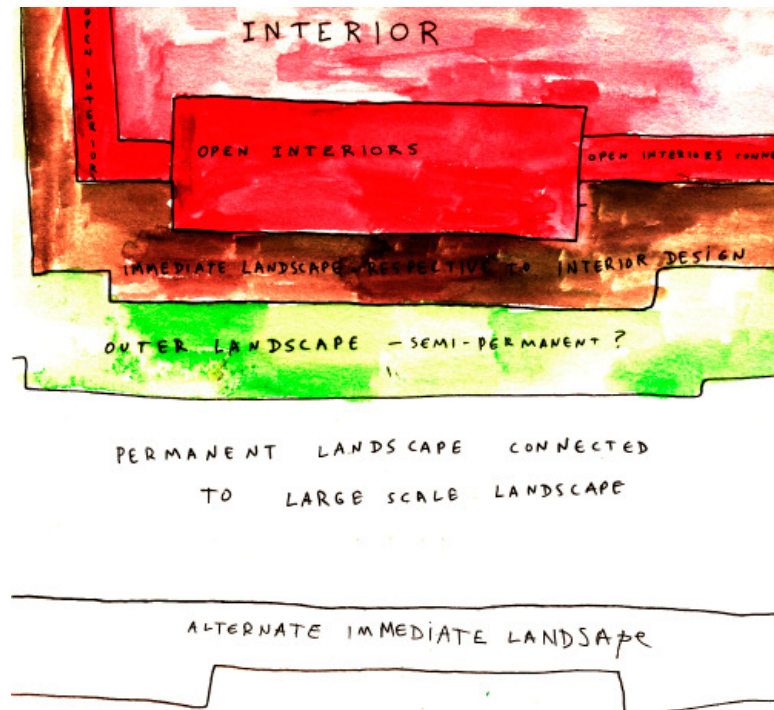

The Embarcadero Center Restaurant proposal

New iconic restaurant significance (connecting Sansome to the walkway).

The walkway ends at the alley and therefore has no facade presence on Sansome st. (as opposed to the other side which ends directly at the Justin Herman plaza, with a strong facade presence).

The method to finish getting the walkway's face out from the alley and out in the open is to do it through the interior, since the open space has evolved over time into being a corridor for worker's meal breaks and commute.

The floor pattern suggests that the walkway area truly does end at Sansome st., for this reason, the restaurant will have an Embarcadero Center theme to it. At the corner of 450 Sansome facing the exterior space, there will be an "Embarcadero Center" title attached in the same fonts and materials as the title at the other end of the walkway (the Justin Herman Plaza title), except in slightly smaller fonts and with the added word "Bistro" under it.

The Embarcadero theme continues inside with the rug pattern resembling the iconic 1960's walkway hardscape pattern in a slightly smaller scale and in a red tone. The furnishings inside, are based on the circles and circle deconstruction theme.

#### -Restaurant function

In short interviews, workers mentioned the need for a more immediate food place option, especially during the lunch and brunch times and with more general variety (because the two nearest restaurants are specialized ethnic foods). In addition, the restaurant would mark the first of a series of Embarcadero establishments and it would be the first to invite the people to openly traverse the interior as part of the walkway tour, without the necessity to purchase food there every time they pass through.

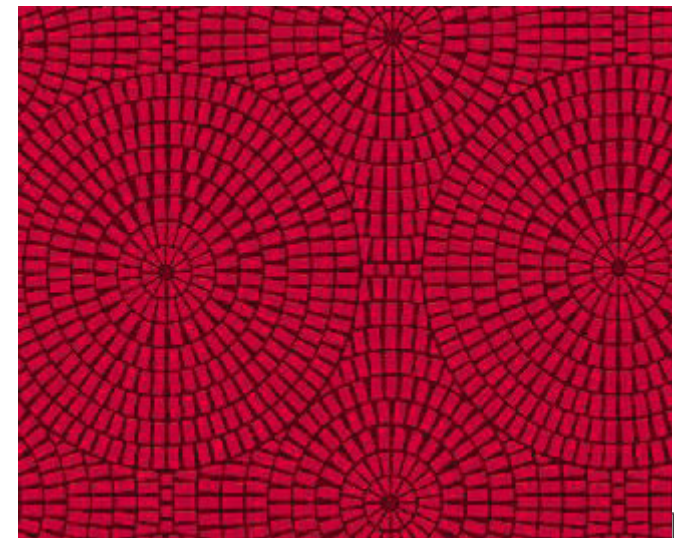



-Open Interior function and attributes: The Interior Ramp.

The initial concept's gradient idea remains, however the exchange of Interior and exterior through materials and influences is used to cut through the gradient to create new sections that dwell in the many small scale zones.

In the design, the Landscape has been introduced into the Interior through continuous plantings, slope and materials and has yielded a continuous path from outside in. This interior pathway is a shortcut for the 450 Sansome office building workers to go through, instead of going around through the site, the street and then the lobby entrance, they can cut through and arrive next to the lobby entrance, therefore it is not a main traffic way.

In addition, a sliding door feature has been added to the newly implemented glass walls. On sunny days, this sliding structure can be opened by sliding it and creating this accordion window position that creates another interior seating space with open roof. This feature also unites the exterior and the interior quarter circle seating areas for informal meetings or for small groups.

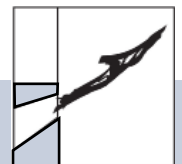

# Site Master Plan Drawing

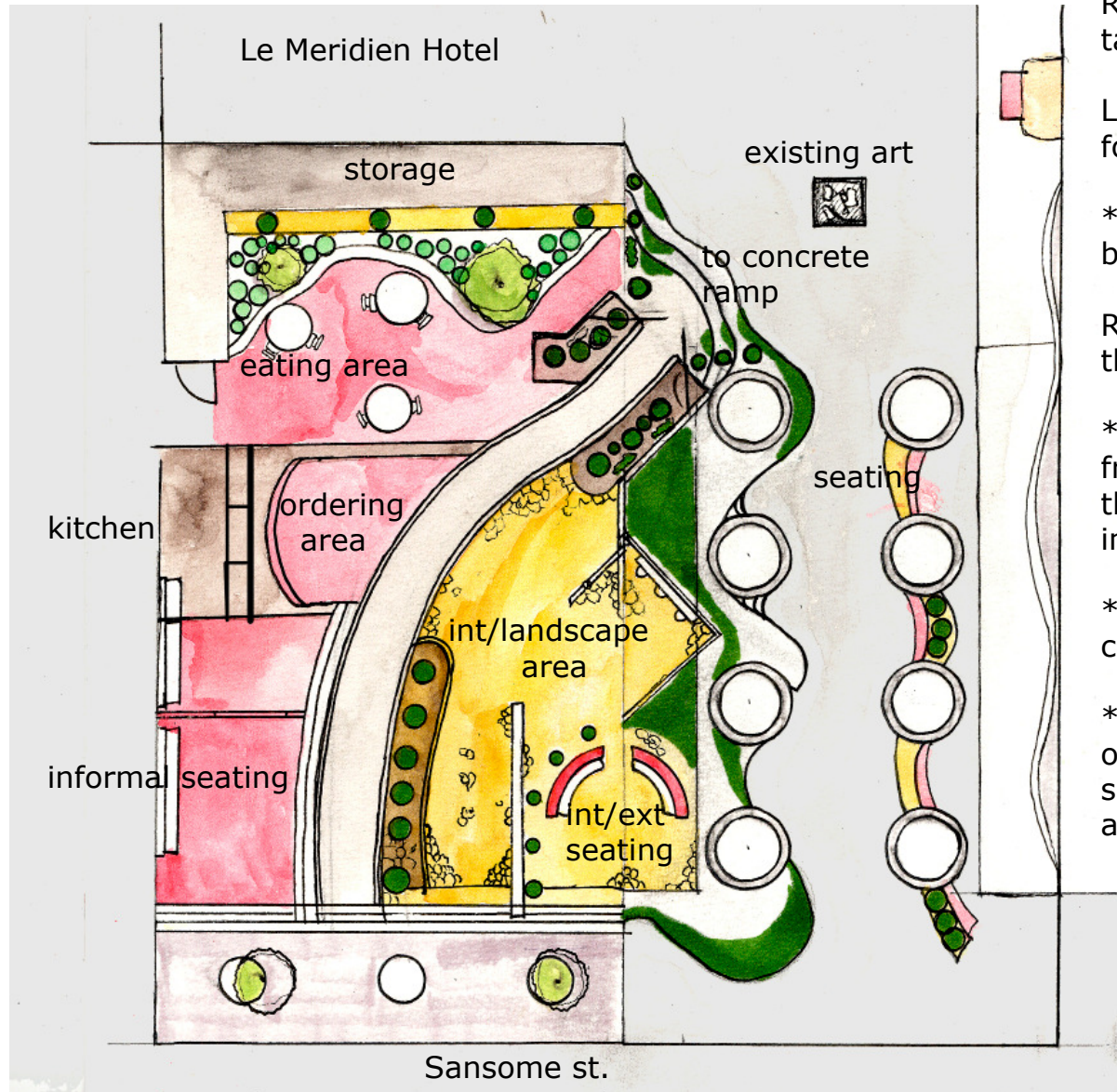

Red: Interior materials for the restaurant's territory.

Light Orange: Landscape hardscape for interior and landscape connection.

\*Accordion windows are shown as being open.

Red (on planters) outside rugs for the seating areas.

\*The restaurant area is accessible from the front stairs or from the middle of the ramp (that goes into the ordering area).

\*The int/Landscape area is only accessible from the front stairs.

\*This is done to give the bistro its own space even though it is in the same room as the hybrid seating area, it is divided by the ramp.

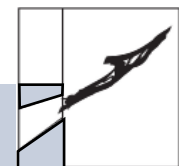



Site Physical Model

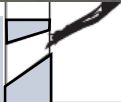
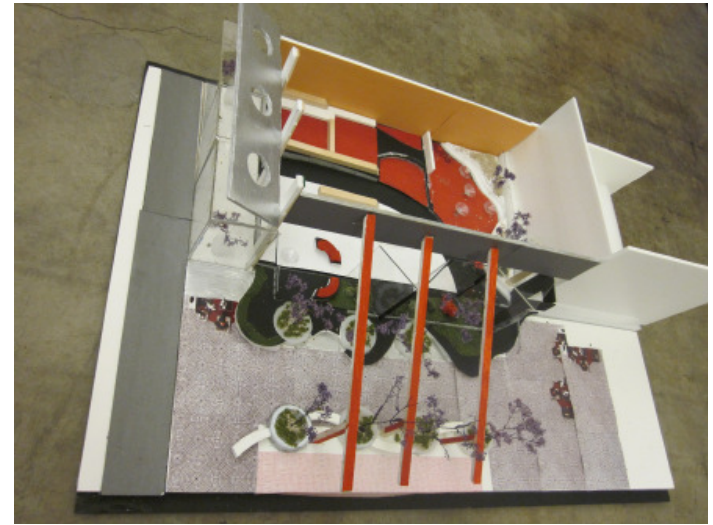



Plants used in the continuous plantings

Species	Common name	Sun/Shade
Polystichum munitum	'Sword fern'	shade
Platycterium bifurcatum	'Staghorn Fern'	shade
Begonia coccinea	'Angel wing begonia'	shade
Begonia 'Silver Splendor'	Begonia, Hardy	shade
Cyclamen spp.	Cyclamen	shade
Echeveria glauca	Echeveria	partial sun
Pelargonium x hortorum	Pelargonium	partial sun
Asparagus densiflorus	Asparagus fern	partial sun
Clivia miniata	Bush lily	partial sun
Primula vulgaris	Common primrose	partial sun

Existing (outside) species:

Asparagus densiflorus	Asparagus fern	partial sun
Maytenus boaria	Mayten	full sun

Plants used Inside only...

Punica (dwarf)	pomegranate	partial sun
Lagerstroemia indica 'Nana'	Peppermint Crape Myrtle	full sun

\*Lagerstroemia will be used inside the Glass Pavilion in order to provide full sun.

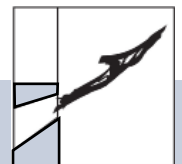

## Embarcadero shapes theme

On first inspection of the site, it is very evident that many forms of circles can be seen throughout the site and also the Embarcadero complex. The boldest manifestation of these is on the ground pattern. The abstract circles made up of circulating brick units make a compelling pattern that looks as if created by raindrops hitting the ground throughout the walkway territory. At the 450 Sansome site, the circles (spheres in this case) continue with the lollypop shaped bike racks that are next to the Federal Reserve, and of course, the eight 7' diameter Mayten tree planters. In addition, even the embarcadero "e" logo at the entrance between Sansome and Battery streets, is a circle with the bottom right cut and brought in to create this lower case e.

In the site design, the circle theme is carried to create new forms. For example, this thin, site cast concrete mask serves to take the angles off of this air vent on the old SF Federal Reserve, so that it becomes part of it's surroundings. This circle with iron within is also first seen at (as) the Embarcadero Bart station tunnel, so there are connections in the commuting worker's path.

\*The mask is cast on the ground in order to keep the air passage to the vents present



## Main doors to interior ramp

The main doors to the ramp are a hint to deconstructivism. The doors function as conventional doors, but with the added horizontal section functioning to close an upper opening in the glass structure. When the doors are opened inward, they create angled walls in the interior and in doing so, they make the horizontal members swing outward to create angles within the opening.

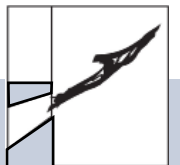
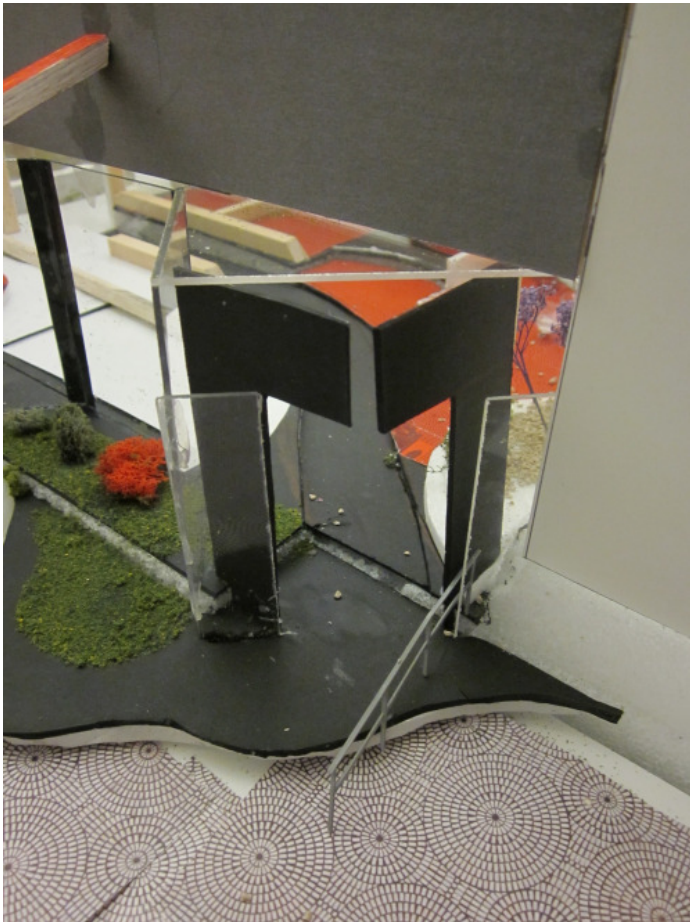
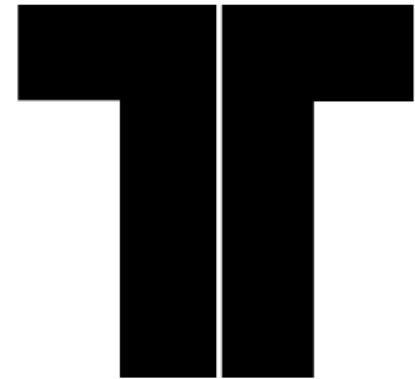



## Textiles used

**Exterior Textiles:** These textiles are fabricated to be used in the out door setting, although, they can also be continuous and be used indoors.

The color and texture resist sunlight and the fabric itself resists mold. Outdoor textiles are not an extra cost issue as oppsed to indoor textiles.

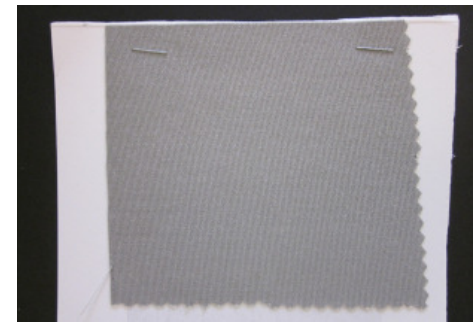
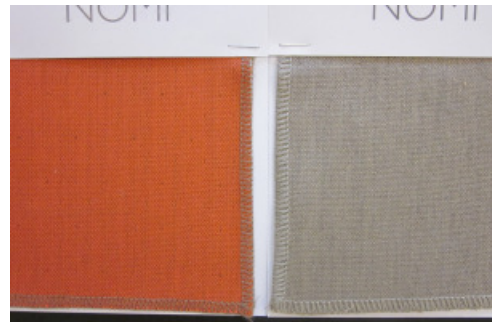

The strong red and orange textile is used to bring the interior color scheme out. It is a brighter fabric that hints to the interior's red and burgundy scheme. The grey and cream textile appeals to the semi contemporary theme of the Embarcadero center, and it also complements the grey fabrics which mimic the concrete found throught the outside space.

**Interior Textiles:** These textiles offer a wide range of patterns and textures designed only for Interior use. A subtle circles theme is carried through furniture, on counters, small tables and behind the main doors.

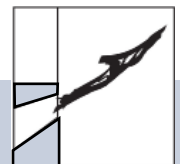

Wallpaper used

Wallpaper used in the interiors under counters and on a few section of the lower wall.

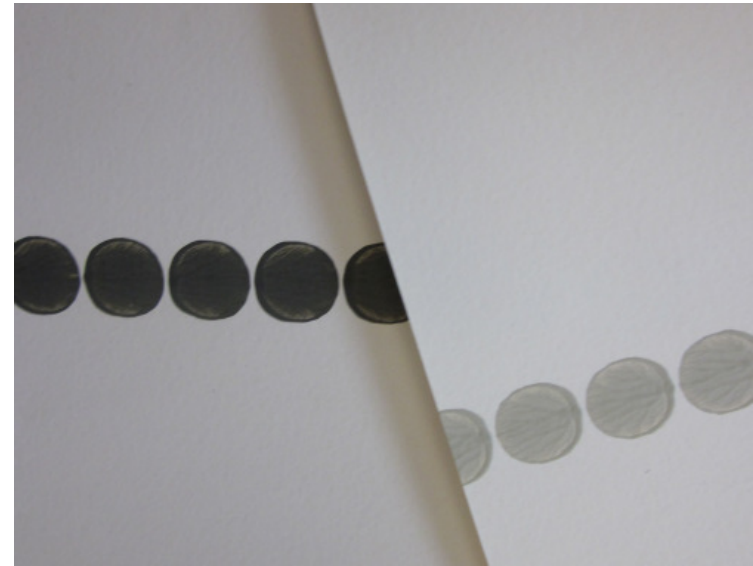
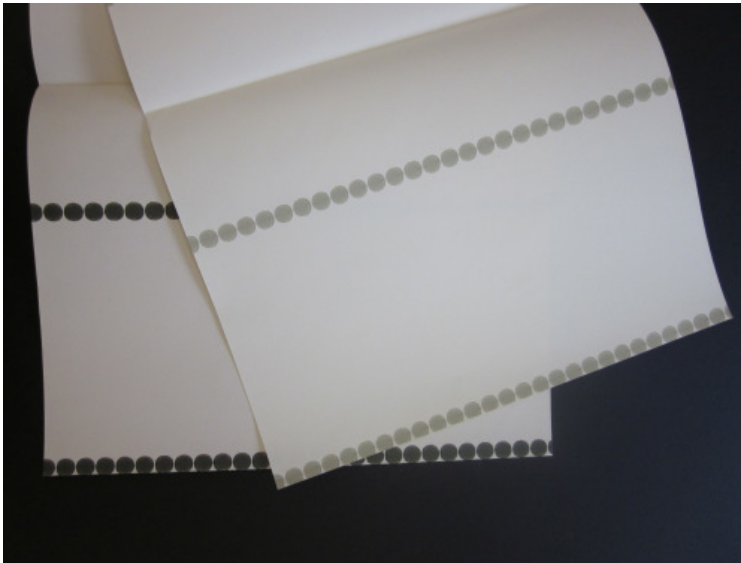

Abstract vine like design  
wallpaper to be used  
behind interior planting  
areas.

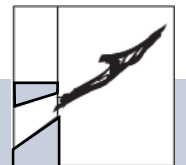
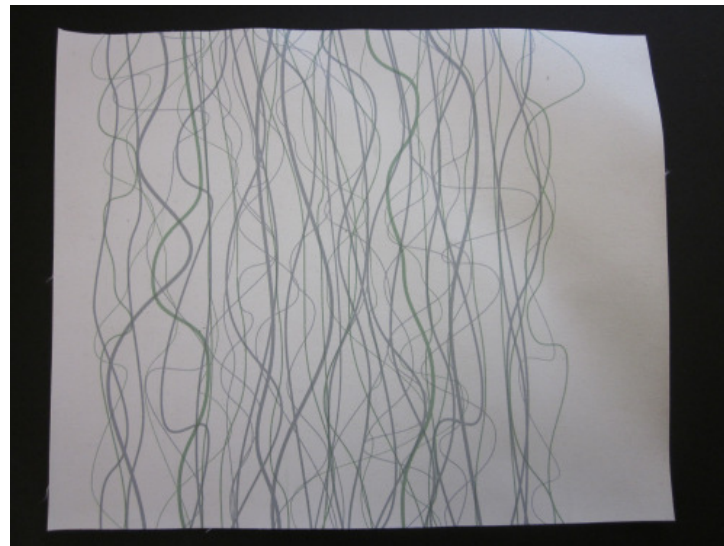

## Rugs used

Exterior: Exterior rugs are usually made up of tinted synthetic materials that will not deteriorate over time.

This next samples are to be used in the Interior+Landscape area (with seating) the ramp entrance, and in small sections under the two seating areas that are created by the curving gesture that goes through the right side Mayten tree planters.

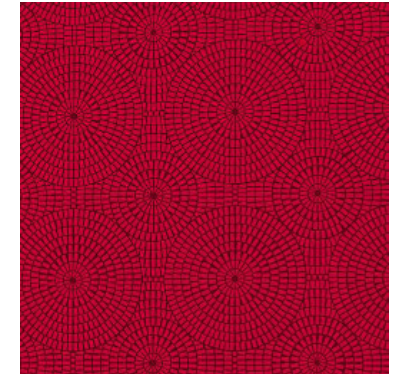
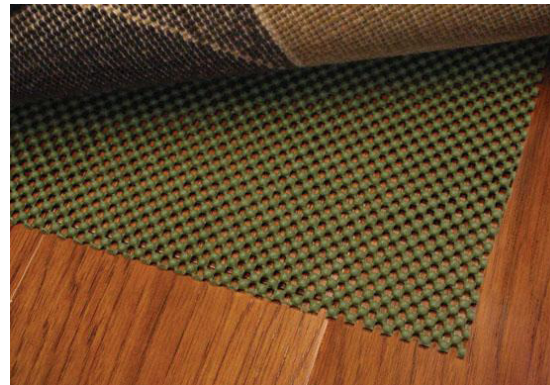

Interior rug

Custom rug with the exterior brick pattern.

## Interior Lights used

The circle lights create a dramatic illumination during dinner time. They continue the circle pattern of the Embarcadero to the inside walls of the restaurant near the seating. The light's illumination can be manually set for light intensity.

The lights in the middle image have a glass plate going through and which serves as the illuminated surface that lights up the bar of the restaurant.



Top, glass plate bar lights  
right: wall light turned on  
at farther illumination.





## Material Boards: Interior Design Influence.

part of the beauty of Interior design is picking the right scheme of products to implement. Material boards present options within parameters set by the Interior designer. Here are some picked out options for possible materials for this project.



Interior and exterior textiles and teak samples, wallpapers and some furniture.

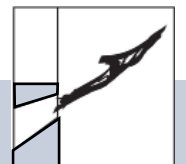

Interior and Exterior Teak:  
2 types of finishes

The left side sample has a finish which looks more glossy/waxy and has less friction. This finish is intended solely for interior use.

On the other hand, the sample on the right side has a less smoothed finish that looks more natural. This finish is intended for outside use, although, if the furniture is movable, it can be used inside.

The cost of both types of finishes is the same.



Other furniture used:

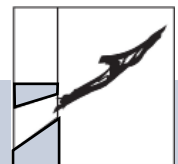
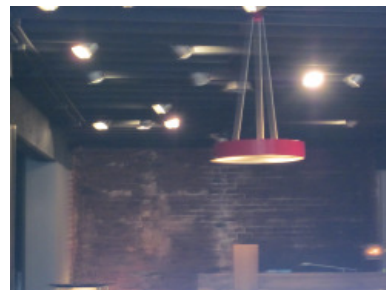



## Lighted Trellis design



The lighted trellis design creates a focal point that attracts people to go in through a gradient of space that eventually turns into the elevated walkway. The users should find the new space more accessible because it is more of a destination/corridor hybrid that instead of a long corridor (like the existing condition in which; if the user is to engage the space, then he must commit to traversing it, and this can turn away people from going in because it is not exactly clear where they are going and how long they have to commit to this pathway. In the new design, the user doesn't feel such commitment because the site takes the role of destination, but still functions as a clear pathway. Even though it is a focal point, it is still a secondary element relative to the Glass Pavilion as to create a hierarchy within these unconventional forms that complement the tall buildings. Lights are placed under the trellis to light at night.

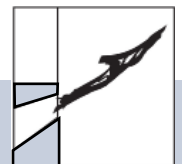



## Lighted Fountains for Rainy Days



The lighted fountain design is used in the permanent landscape in this case, using more permanent materials. The fountains gather water from water catchment containers at the side of the glass that is placed over the trellis. One water pressure container is placed at the side nearing battery street and this lights the row of fountains and distribute the water sideways and down for display. On rainy days, these help illuminate the atmosphere and remind the users that this corridor is under a canopy that catches the element they are trying to avoid contact with and turns it into a calm water backdrop with and light and thus becomes a special event that only comes during the rain season.

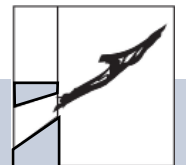

## Connection to Landscape system

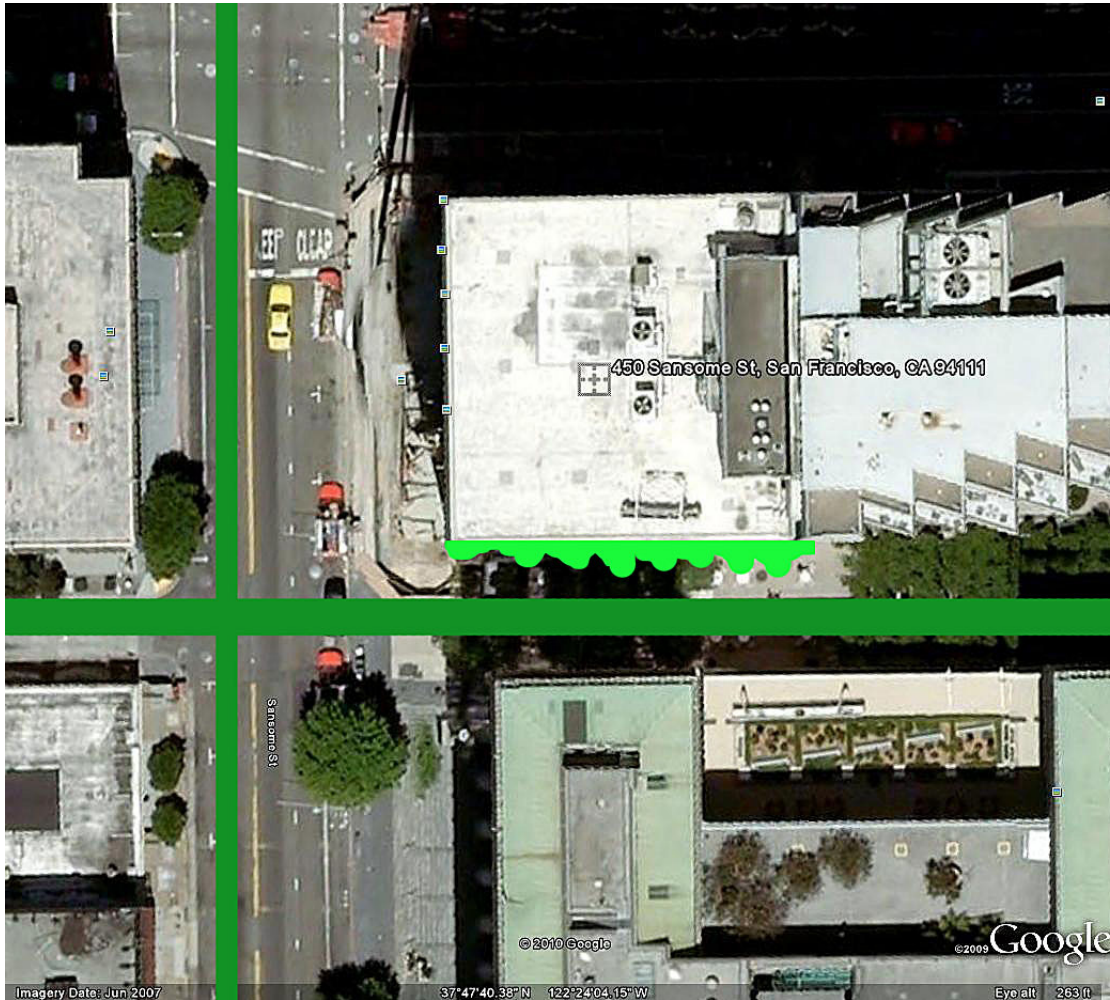

Light Green:  
Temporary Landscape:  
Accessible to renovation  
with the interiors.

Darker Green:  
More permanent Landscape  
joining to the large scale  
landscape system.

The large scale connection  
in the site design are the  
2 main paths between the  
planters that will remain  
open to flowing pedestrian  
traffic.

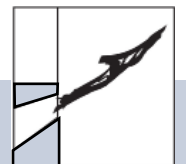



## Conclusions:Log

*In doing this project, I realized even further how a simple accessible reference or hint to the landscape outdoors is needed during certain times of the day. Having a place that is readily accessible and away from the wind and elements can seem many times like the ideal contemplation spot when total immersion in a landscape is also not desired at that moment. I think city scapes need spaces like these in parts of the city, although it is a challenge to make it safe and at the same time accessible. There should be many formulas to develop a good Interior+Landscape place that may be developed upon many concepts of Landscape reference in the interiors or vice versa; landscapes with the added warmth and comfort of interior influence. The author's concepts presented in this work stem from the influences of both professions and from opportune situations where these concepts look to work. I think it would be exciting if concepts such as these and previous ones by professionals continued to be developed and take prominent roles where applicable.*

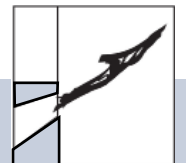



## V.)Bibliography:

-Blaisse P. 2009: Inside/Outside, London UK, Monacelli press

-Berrizbeitia A. and Pollak L. 2003 :Inside Outside: Between Architecture and Landscape, Rockport publishers: Illustrated edition edition.

-Wigley M. 1988: Deconstructivist Architecture

-Weinthal L. 2008: Bridging the Threshold of Interior and. Landscape: An Interview with Petra Blaisse: Architectural Design: Interior Atmospheres No. 3 pg. 67-71

-Moussette M. 2003: 'Do we need a canopy for rain?': interior-exterior relationships in the Kunsthal: Architectural research quarterly, no. 3/4 (2003): pg. 280-294

-Raume V. 2006: Converted Spaces, Taschen, Koln Germany

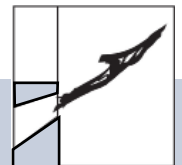

## Image urls

[http://tyrumas.com/library/faucet\\_DRINK200.jpg](http://tyrumas.com/library/faucet_DRINK200.jpg)

[http://gocviet.vn/gocviet/editor\\_upload/20080923150831.jpg](http://gocviet.vn/gocviet/editor_upload/20080923150831.jpg)

[http://gocviet.vn/gocviet/editor\\_upload/20080923150831.jpg](http://gocviet.vn/gocviet/editor_upload/20080923150831.jpg)

<http://trendhousedesign.com/wp-content/uploads/2010/02/Interior-Courtyards.jpg>

<http://treesflowersbirds.files.wordpress.com/2010/01/rain.jp>

<http://www.apartmenttherapy.com/uimages/ny/1-9-vertical-garden-1.jp>

[http://www.williams.edu/resources/sustainability/green\\_buildings/images/balanced\\_ventilation.gif](http://www.williams.edu/resources/sustainability/green_buildings/images/balanced_ventilation.gif)

<http://homedecorators.com/images/items/large/189809610.jpg>

<http://archinspire.com/wp-content/uploads/2009/03/volumeproportionarchitectural5.jpg> sliding door

<http://www.trendir.com/house-design/villa-allegra-1.jpg>

\*All sketches, computer drawings, model and photoshop work by Jean C. Moreno 2010 except for page #18 which is rendered by Alexandra Witte for her UC Davis Senior Project 2008.

## Acknowledgements:

Thanks to my My project committee for all the help and support and to my family for always believing in me and supporting me and to all the people that have helped me throughout my design education.

Special thanks to Lisa Chaffee, Plant Specialist at UC Davis for helping me familiarize myself with Interior/Exterior plants and to Alexandra Witte for letting me use her example in this study.

